



Gas Fire Pit Tables



Scan me!



UPT-1242-IRO with optional FWG-1242

Uptown Iroko

- Iroko wood with linen colored Supercast™ concrete top
- Black aluminum base
- 12" x 42" Crystal Fire® Plus burner
- Grey glass burner cover included
- Sliding access door conceals standard 20 lb. propane tank in base
- 65,000/80,000 BTUs (LP/NG)
- Made in USA with US and imported parts

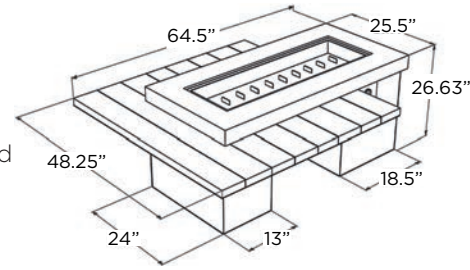

UPT-1242

Uptown Black

- Black tile with Midnight Mist Supercast™ concrete top
- Midnight Storm stucco base
- 12" x 42" Crystal Fire® Plus burner
- Grey glass burner cover included
- Sliding access door conceals standard 20 lb. propane tank in base
- 65,000/80,000 BTUs (LP/NG)
- Made in USA with US and imported parts

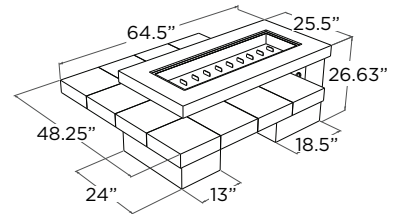

MG-1242-BLSM-K

Balsam Montego

- Black glass top
- Balsam outdoor resin wicker base
- 12" x 42" Crystal Fire® Plus burner
- Grey glass burner cover included
- Access door conceals standard 20 lb. propane tank in base
- 65,000/80,000 BTUs (LP/NG)

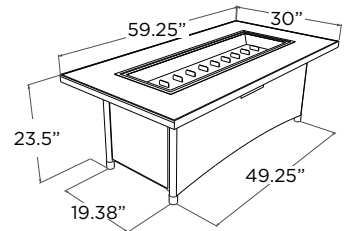

CR-1242-K with optional GLASS GUARD-1242

Cedar Ridge

- Washed Cedar Supercast™ concrete top
- Dark grey composite decking base
- 12" x 42" Crystal Fire® Plus burner
- Matching Supercast concrete burner cover included
- Access door conceals standard 20 lb. propane tank in base
- 65,000/80,000 BTUs (LP/NG)
- Made in USA with US and imported parts

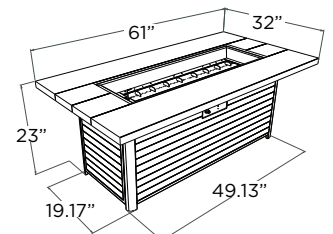



DENBR-1242 with optional FWG-1242

Denali Brew

- Brown Everblend™ concrete top
- Corrugated metal base with mocha wood frame
- 12" x 42" Crystal Fire® Plus burner
- Grey glass burner cover included
- Access door conceals standard 20 lb. propane tank in base
- 65,000/80,000 BTUs (LP/NG)
- Made in USA with US and imported parts

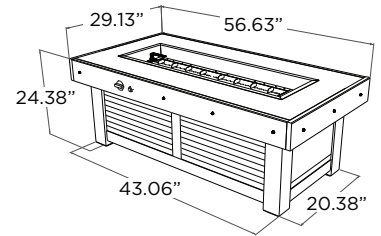

KL-1242-MM

Grey Key Largo

- Midnight Mist Supercast™ concrete top
- Black Fleck stucco base
- 12" x 42" Crystal Fire® Plus burner
- Grey glass burner cover included
- Sliding access door conceals standard 20 lb. propane tank in base
- 65,000/80,000 BTUs (LP/NG)
- Made in USA with US and imported parts

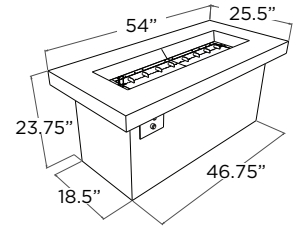

KL-1242-SS with optional GLASS GUARD-1242

Stainless Steel Key Largo

- Stainless steel trim top
- Black Fleck stucco base
- 12" x 42" Crystal Fire® Plus burner
- Grey glass burner cover included
- Sliding access door conceals standard 20 lb. propane tank in base
- 65,000/80,000 BTUs (LP/NG)
- Made in USA with US and imported parts

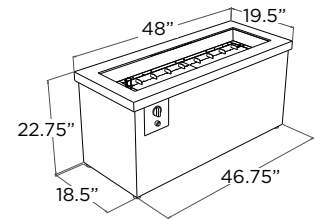

KW-1242-K

Kenwood Dining

- UMBER brown composite decking top and base
- Grey powder-coated aluminum framing
- 12" x 42" Crystal Fire® Plus burner
- Grey glass burner cover included
- Access door conceals standard 20 lb. propane tank in base
- 65,000/80,000 BTUs (LP/NG)

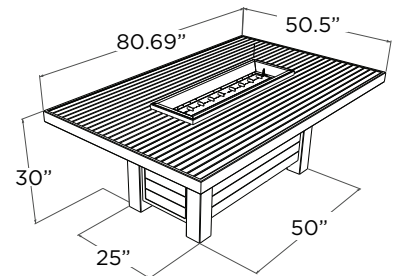

MCR-1242-BLK-K

Monte Carlo

- Black glass top
- Black powder-coated metal base
- 12" x 42" Crystal Fire® Plus burner
- Grey glass burner cover included
- Sliding access door conceals standard 20 lb. propane tank in base
- 65,000/80,000 BTUs (LP/NG)
- Made in USA with US and imported parts

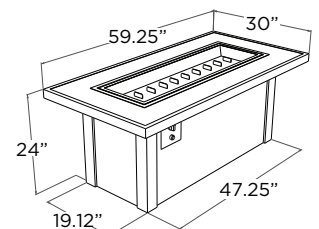



KN-1224

Kinney

- Trillium Everblend™ concrete top
- Black powder-coated metal base
- 12" x 24" Crystal Fire® Plus burner
- Grey glass burner cover included (fits inside base)
- Access door conceals horizontal 20 lb. propane tank — does not fit standard 20 lb. tank
- 55,000 BTUs
- Made in USA with US and imported parts

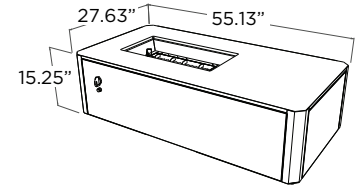

CV-54

Cove 54"

- Natural Grey, White, or Midnight Mist Supercast™ concrete base
- 7" x 37" Crystal Fire® Plus burner insert inside 12" x 42" plate
- Matching Supercast concrete pedestal included
- Does not fit 20 lb. LP tank in base
- 65,000/80,000 BTUs (LP/NG)
- Made in USA with US and imported parts

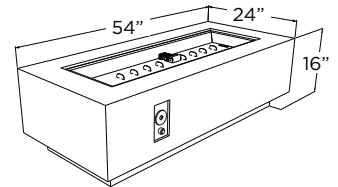

Color options available

Midnight Mist
(CV-54MM)

Natural Grey
(CV-54)

White
(CV-54WT)



CV-72WT

Cove 72"

- White, Midnight Mist, or Natural Grey Supercast™ concrete base
- 7" x 57" Crystal Fire® Plus burner insert inside 12" x 64" plate
- Matching Supercast concrete pedestal included
- Does not fit 20 lb. LP tank in base
- 100,000 BTUs
- Made in USA with US and imported parts

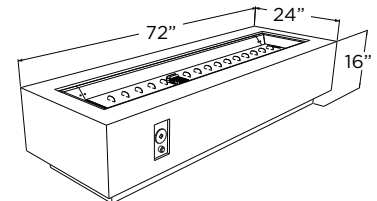

Color options available

Midnight Mist
(CV-72MM)

Natural Grey
(CV-72)

White
(CV-72WT)



ALC-1224 with optional GLASS GUARD-1224

Alcott

- Antique Timber Supercast™ concrete top
- Whitewashed shiplap base
- 12" x 24" Crystal Fire® Plus burner
- Matching Supercast concrete burner cover included
- Sliding access door conceals standard 20 lb. propane tank in base
- 55,000 BTUs
- Made in USA with US and imported parts

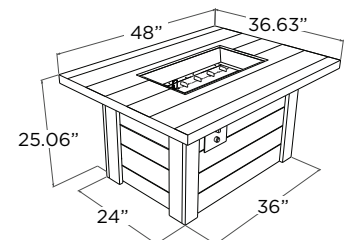



Brooks

- Taupe composite decking top and base
- Grey powder-coated aluminum framing
- 12" x 24" Crystal Fire® Plus burner
- Grey glass burner cover included
- Access door conceals standard 20 lb. propane tank in base when included riser kit is installed on table
- 55,000 BTUs

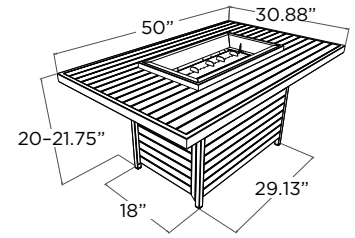

Kenwood Chat

- Umber brown composite decking top and base
- Grey powder-coated aluminum framing
- 12" x 24" Crystal Fire® Plus burner
- Grey glass burner cover included
- Access door conceals standard 20 lb. propane tank in base when included riser kit is installed on table
- 55,000 BTUs

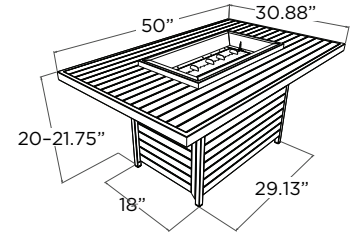

Providence

- Stainless steel trim top
- Black powder-coated metal base
- 12" x 24" Crystal Fire® Plus burner
- Grey glass burner cover included
- Access door conceals standard 20 lb. propane tank in base
- 55,000 BTUs
- Made in USA with US and imported parts

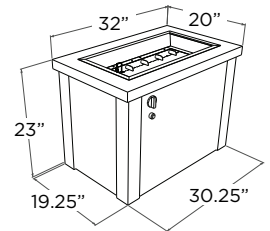

Darien

- Aluminum or Stone Grey Everblend™ concrete top
- Grade A teak wood base
- 12" x 24" Crystal Fire® Plus burner
- Matching burner cover included for aluminum top; grey glass cover included for Everblend concrete top
- Access door conceals standard 20 lb. propane tank in base
- 55,000 BTUs

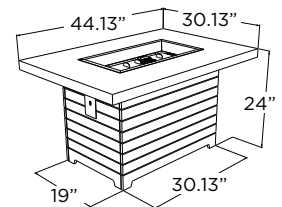

Top options available

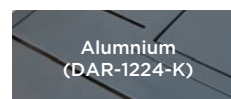
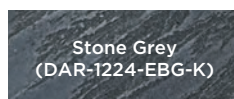



Grey Havenwood

- Driftwood or Stone Grey Everblend™ concrete top
- Grey powder-coated metal base
- 12" x 24" Crystal Fire® Plus burner
- Grey glass burner cover included
- Access door conceals standard 20 lb. propane tank in base
- 55,000 BTUs
- Made in USA with US and imported parts

Top options available

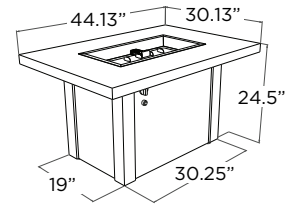
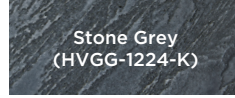

White Havenwood

- Stone Grey or Driftwood Everblend™ concrete top
- White powder-coated metal base
- 12" x 24" Crystal Fire® Plus burner
- Grey glass burner cover included
- Access door conceals standard 20 lb. propane tank in base
- 55,000 BTUs
- Made in USA with US and imported parts

Top options available

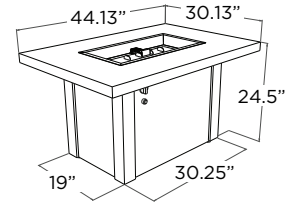
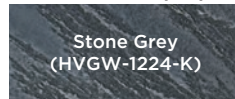

Brown Stonefire

- Dora brown composite top
- Brown powder-coated aluminum frame with brown mesh base
- 16" Crystal Fire® Plus burner insert
- Matching composite burner cover included
- Access door conceals standard 20 lb. propane tank in base
- 55,000 BTUs

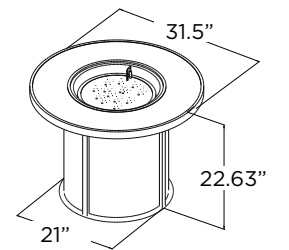

Grey Stonefire

- Grey composite top
- Grey powder-coated aluminum frame with grey mesh base
- 16" Crystal Fire® Plus burner insert
- Matching composite burner cover included
- Access door conceals standard 20 lb. propane tank in base
- 55,000 BTUs

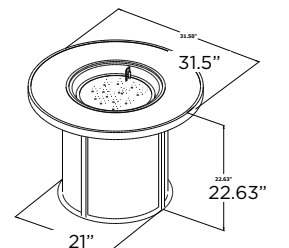



ED-20 with optional GLASS GUARD-20-R

Edison

- Grey Barnwood Supercast™ concrete top
- Pewter Crater powder-coated metal base
- 20" Crystal Fire® Plus burner
- Matching Supercast concrete burner cover included
- Sliding access door conceals standard 20 lb. propane tank in base
- 55,000 BTUs
- Made in USA with US and imported parts

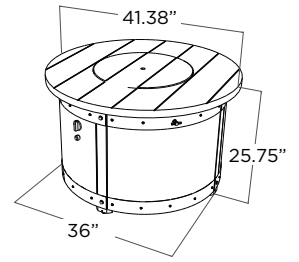

BC-20-MNB with optional GLASS GUARD-20-R

Marbleized Noche Beacon

- Marbleized Noche Supercast™ concrete top
- Brown powder-coated metal base
- 20" Crystal Fire® Plus burner
- Matching Supercast burner cover included
- Sliding access door conceals standard 20 lb. propane tank in base
- 55,000 BTUs
- Made in USA with US and imported parts

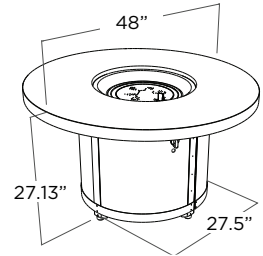

BC-20-WO

White Onyx Beacon

- White Onyx Supercast™ concrete top
- Grey powder-coated metal base
- 20" Crystal Fire® Plus burner
- Matching Supercast burner cover included
- Sliding access door conceals standard 20 lb. propane tank in base
- 55,000 BTUs
- Made in USA with US and imported parts

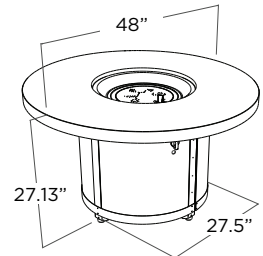

BRON52-K with optional BRON52-CG-TC

Bronson Round Kit

- Build-your-own gas fire pit kit
- 28" Crystal Fire® Plus burner insert inside 42" round plate
- Includes pavers (84), control panel, 2 vent blocks, and tumbled lava rock (72 lbs.)
- Does not fit 20 lb. LP tank in base
- 105,000/106,000 BTUs (LP/NG)
- Made in USA with US and imported parts

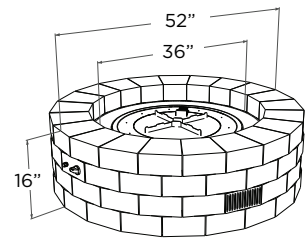

BRON5151-K

Bronson Square Kit

- Build-your-own gas fire pit kit
- 28" Crystal Fire® Plus burner insert inside 42" square plate
- Includes pavers (64), control panel, 2 vent blocks, and tumbled lava rock (78 lbs.)
- Does not fit 20 lb. LP tank in base
- 105,000/106,000 BTUs (LP/NG)
- Made in USA with US and imported parts

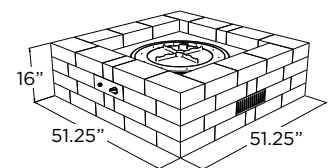



CV-20

Cove 29"

- Natural Grey Supercast™ concrete base
- 20" Crystal Fire® Plus burner
- Grey glass burner cover included
- Does not fit 20 lb. LP tank in base
- 55,000 BTUs
- Made in USA with US and imported parts

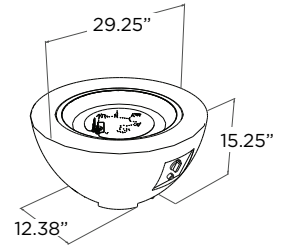

CV-30WT

Cove 42"

- White, Midnight Mist, or Natural Grey Supercast™ concrete base
- 30" Crystal Fire® Plus burner
- Grey glass burner cover included
- Does not fit 20 lb. LP tank in base
- 105,000/106,000 BTUs (LP/NG)
- Made in USA with US and imported parts

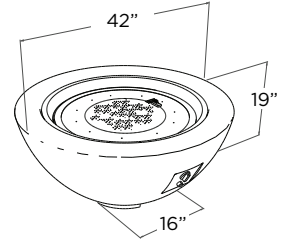

Color options available

Midnight Mist
(CV-30MM)

Natural Grey
(CV-30)

White
(CV-30WT)



CV-30EMM

Cove Edge 42"

- Midnight Mist, White, or Natural Grey Supercast™ concrete base
- 28" Crystal Fire® Plus burner insert inside round plate
- Does not include burner cover
- Does not fit 20 lb. LP tank in base
- 105,000/106,000 BTUs (LP/NG)
- Made in USA with US and imported parts

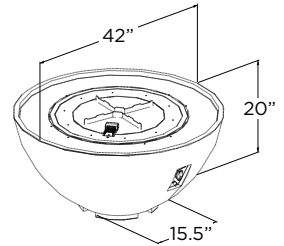

Color options available

Midnight Mist
(CV-30MM)

Natural Grey
(CV-30E)

White
(CV-30EWHT)



CV-2424 with optional GLASS GUARD-2424

Cove Square

- Natural Grey Supercast™ concrete base
- 24" x 24" Crystal Fire® Plus burner
- Grey glass burner cover included
- Access door conceals standard 20 lb. propane tank in base
- 55,000 BTUs
- Made in USA with US and imported parts

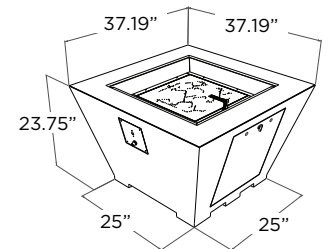

SIERRA-2424-M-K

Sierra

- Mocha Supercast™ concrete top
- Faux stacked stone base
- 24" x 24" Crystal Fire® Plus burner
- Matching Supercast concrete burner cover included
- Sliding access door conceals standard 20 lb. propane tank in base
- 55,000 BTUs
- Made in USA with US and imported parts

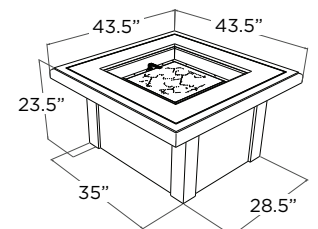



Accessories



Amber
CFG-A

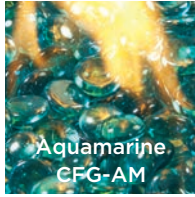

Aquamarine
CFG-AM

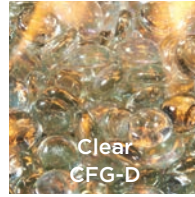

Clear
CFG-D

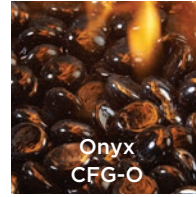

Onyx
CFG-O



Ruby
CFG-R



Black Diamonds
CFLD-B



Copper Diamonds
GFLD-C



Black Lava Rock
LAVA-BLK



Ceramic Log Set
CF20-LOG SET



Tumbled Lava Rock
LAV-TMB

Fire Media

Tempered fire glass lights up the fire pit table with an ember-like glow. Complete your gas fire pit table or outdoor fireplace with beautiful tempered glass gems or lava rock. Choose from many shapes, sizes, and colors to create a custom look — you can even mix and match!

- Find your favorite for a unique, custom look
- Seven glass media gems to choose from
- Black lava rock, tumbled lava rock (2 different sizes), and ceramic log set favor a more natural look
- Realistic-looking ceramic log set includes six wood pieces
- Clear tempered glass gems (CFG-D) included with all fire pit tables



GLASS GUARD-1264

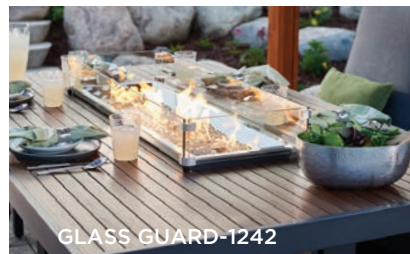

GLASS GUARD-1242



GLASS GUARD-1224



GLASS GUARD-20-R



GLASS GUARD-2424

Glass Wind Guards

Glass wind guards look beautiful with the reflection of the dancing flames. Glass guards are available to fit any standard Crystal Fire® Plus burner.

- Reduces wind effect and provides a safety barrier for children and animals
- Tempered glass panels
- Stainless steel hardware — round glass wind guards feature a stainless steel rod for added durability
- Easy to set up and clean



FWG-1224 (up)



FWG-1224 (down)

Folding Wind Guards

The convenience of a glass wind guard and burner cover in one. Place the panels of glass up to protect the flame from the wind, and place them down to cover your burner when not in use. Available in two sizes: 12" x 24" (FWG-1224) and 12" x 42" (FWG-1242). Patent pending.

- Sits on top of burner trim
- Clear tempered glass
- Stainless steel hardware
- Easy to set up and clean

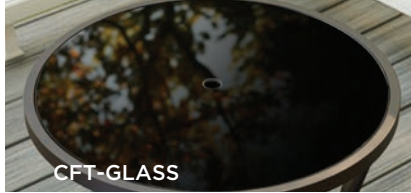

Burner Covers

Turn your beautiful fire pit into a functional table by covering the burner with one of our stylish burner covers. Covers also add an extra layer of protection from rain and debris when not in use.

- Grey glass burner covers are included with most fire pit tables; available for all burner sizes
- Select Supercast™ tables come with matching Supercast burner covers
- Add a stainless steel burner cover to CV-54, CV-72, or other select linear models
- Add a lazy susan ring or black glass cover to any of our 20" round burner covers



Protective Covers

Protect your investment with protective covers from OGC! Protective covers are great for storing items long term or for everyday use.

- Available for most fire pit tables
- Tan polyester fabric stays cool to the touch
- Tear-resistant, rip-stop laminating
- Drawstring cord at bottom to secure to fire pit
- Polyester velvet interior protects finished material
- One-way breathability: exterior is water-resistant while being one-way breathable to let any interior moisture out



Stainless Steel Trim

Compliment the unique look of the 54" and 72" Cove Linear tables (CV-54, CV-72) with this modern stainless steel top.

- Available in two sizes: 54" (SS54T) and 72" (SS72T)
- #304 commercial-grade stainless steel construction
- Adds layer of protection to concrete surface
- Easy to clean



Bronson Concrete Tops

Complete your Bronson round gas fire pit kit with an elegant, contemporary concrete top.

- Choose between two colors: Limestone Tan (BRON52-LT-TC) or Charcoal Grey (BRON52-CG-TC)
- Four pieces included with each SKU

Color options available

Limestone Tan
(BRON52-LT-TC)

Charcoal Grey
(BRON52-CG-TC)



Outdoor Furniture



DAR-CH (table not included)

Darien Chairs

- Grey powder-coated aluminum frame with Grade A teak accents
- Cushions provide deep, comfy seating
- Grey outdoor-rated Olefin fabric
- Pair with Darien gas fire pit tables (DAR-1224-K or DAR-1224-EBG-K)
- Set of 2

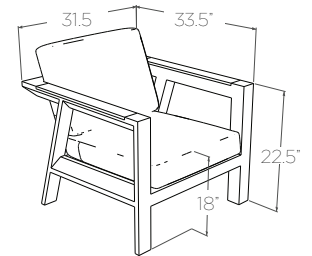

EMPIRE-BAR (table not included)

Empire Bar Stools

- Taupe outdoor-rated fabric with padded sling
- Dora brown powder-coated aluminum frame
- Perfect height for pub tables and outdoor kitchens
- Swivel bar stool
- Set of 2

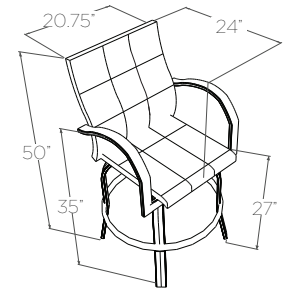



NAPLES-4030-L (table not included)

Naples Bar Stools

- Leather brown outdoor resin wicker
- Dora brown powder-coated aluminum frame
- Perfect height for pub tables and outdoor kitchens
- Swivel bar stool
- Set of 2

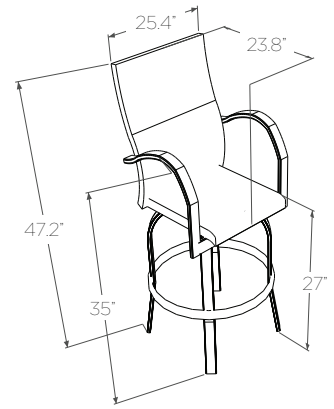

KW-LB and KW-SB

Kenwood Benches

- Umber brown composite decking
- Grey powder-coated aluminum frame
- Pair with Kenwood gas fire pit tables (KW-1224-19-K or KW-1242-K)
- Benches sold individually

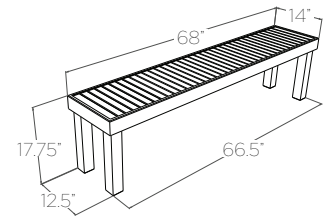
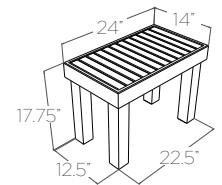

INT-EZ

Intrigue Outdoor Lantern

- Spinning Venturi flame designed to fit any table with an umbrella hole from 1.4"–4"
- Dora brown powder-coated finish
- Easy to assemble
- Single glass cylinder
- Use with 1 lb. propane tank
- For outdoor use only
- Includes black rubber glass lid
- Optional cover (CVRINT) sold separately
- UL and ULC listed

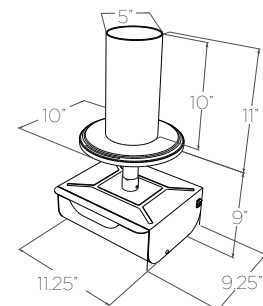



the **outdoor**
greatroom
company